



AUSTRALIAN CASTING FEDERATION

A0041705E

BY- LAWS

and

CASTING RULES

FLY CASTING SECTION 1
WEIGHT CASTING SECTION 2
PLUG CASTING SECTION 3

Effective from 1st January 2008

© Copyright, all rights reserved

CONTENTS

BY-LAWS

<u>BRUNN SHIELD TEAM EVENT</u>	7
<u>CERTIFICATES</u>	7
<u>CHAMPION OF CHAMPIONS</u>	5
<u>CHAMPION OF CHAMPIONS (OVERALL)</u>	6
<u>CHAMPION OF CHAMPIONS (SECTION)</u>	6
<u>CHANGES TO BY-LAWS</u>	1
<u>CONDUCT OF AUSTRALIAN, STATE AND TERRITORY TOURNAMENTS</u>	3
<u>CONDUCT OF SANCTIONED TOURNAMENTS OR EVENTS</u>	1
<u>ELIGIBILITY</u>	1
<u>ENTRIES</u>	3
<u>ENTRY TIME</u>	2 & 3
<u>EVENTS (CHAMPIONSHIP STATUS)</u>	9
<u>EVENTS (OTHER)</u>	9
<u>GRADINGS</u>	4
<u>INTERNATIONAL CASTERS</u>	7
<u>INTERPRETATION</u>	1
<u>JUDGES</u>	3
<u>MEDALLIONS</u>	7
<u>PRACTICE CASTING</u>	2
<u>PROTESTS</u>	2
<u>QUALIFYING</u>	4
<u>RECORDS</u>	8
<u>RECORDS (BREAK)</u>	8
<u>SANCTIONS</u>	1
<u>SCORING METHOD</u>	5
<u>TIES</u>	6
<u>TOURNAMENT COMMITTEES</u>	2
<u>TROPHIES</u>	7

CASTING RULES

FLY CASTING SECTION 1

RULES ALTERATION	10
INTERPRETATION	11
ACCURACY FLY	12
GENERAL RULES	12
Illegal cast	12
Lost fly, leader, broken tackle	12
Determining results	13
Fly size	13
Skip fly	13
Platform and or casting box	13
Judging	13
ACCURACY FLY EVENTS	14
AUSTRALIAN DRY FLY ACCURACY	14
AUSTRALIAN SKISH FLY ACCURACY	14
ICF SKISH FLY ACCURACY	18
AUSTRALIAN WET FLY ACCURACY	21
DISTANCE FLY	22
GENERAL RULES	22
Illegal cast	22
Lost fly, leader, broken tackle	22
Determining results	22
Fly size	22
Skip fly	22
Platform and or casting box	22
Judging	22
DISTANCE FLY EVENTS	23
ICF FLY ACCURACY AND DISTANCE (FAD)	23
CASTING THE FAD ACCURACY	23
CASTING THE FAD DISTANCE SINGLE-HANDED	24
ICF FLY DISTANCE SINGLE-HANDED	25
ICF FLY DISTANCE DOUBLE-HANDED	26

WEIGHT CASTING SECTION 2

DISTANCE CASTING	27
CONDUCT OF TOURNAMENT FOR WEIGHT CASTING	28
PENALTIES FOR WEIGHT SECTION	28
ARTIFICIAL BAIT DISTANCE	28
ARTIFICIAL BAIT ACCURACY	29

PLUG CASTING SECTION 3

DISTANCE CASTING	30
PLUG ACCURACY CASTING SECTION	32
SPINNING ACCURACY ARENBERG	33
7.5 GRAM SKISH PLUG	34
7.5 GRAM SINGLE HANDED DISTANCE	35
18 GRAM DOUBLE HANDED DISTANCE (FIXED SPOOL)	36
18 GRAM SKISH PLUG	37
18 GRAM DOUBLE HANDED DISTANCE (REVOLVING DRUM)	38

TERMINOLOGY

TERMINOLOGY USED IN THE BY-LAWS AND CASTING RULES	39
---	----

BY-LAWS

CHANGES TO BY-LAWS

As per the Australian Casting Federation's Statement of Purpose **15.2 (d) the Committee** may create and amend rules, terminology and regulations governing the administration of fly, weight and plug casting tournaments and championships (the 'By-Laws')

INTERPRETATION

Where the By-Laws, Casting Rules or Terminology of the Australian Casting Federation are inconsistent with those of the International Casting Federation, the By-Laws, Casting Rules and Terminology of the Australian Casting Federation will take preference.

SANCTIONS FOR TOURNAMENTS OR EVENTS

- Any tournament or event may be sanctioned by the Federation on the following conditions:
- An application in writing specifying the proposed tournament or event date, place and programme will be in the hands of the Secretary accompanied by the appropriate fee for the same, at least twenty eight (28) days before the proposed date.
- It will be understood that the tournament or event must be held on the date sanctioned.
- The words "Conducted under the Sanction of the Australian Casting Federation" will appear on all notices, score sheets and other documents for such tournaments or events.

CONDUCT OF SANCTIONED TOURNAMENTS OR EVENTS

WHO IS ELIGIBLE TO COMPETE?

- Sanctioned tournaments and or events will be open only to Junior and Senior ACF Registered Casters. (*Private Members, Life Members, Honorary Members and Members of Affiliated Clubs are required to be registered*). (See below for Non-registered Affiliated Club casters.)
- Each competitor will compete once only in any Sanctioned event.
- Nothing herein contained will prevent any Affiliated Club from conducting a closed event concurrently with any event on the programme.
- Non-registered Affiliated Club casters are permitted to compete in a closed event (except at Australian State or Territory Championships) conducted concurrently with any event on the programme.

ENTRY TIME (EXCEPT AUSTRALIAN, STATE OR TERRITORY CHAMPIONSHIPS)

- No further entries will be accepted once the first (1st) event on the day has been completed.

Where **Private Membership** is being sought on the same day as the tournament, application forms must be submitted up to 30 minutes prior to the commencement of the tournament.

- Competitors will present themselves within one (1) minute when called to cast. Non-compliance may entail disqualification. Should competitors be unavailable when called owing to participation in another event, judging or scoring at the time, they will present themselves to the judge or scorer as soon as possible; the judge or scorer will then indicate the order in which they are to cast.

PRACTICE CASTING

- The Tournament Committee will remove all practice hoops from the water immediately prior to the commencement of the tournament
- At no time will a caster be permitted to cast at hoops or targets that have been set out for an event prior to the commencement of that event. The penalty for this action will be disqualification.
- Casters are permitted to practise on hoops or targets immediately after completion of each event until such time as the tournament committee wishes to relocate them for the next event.

TOURNAMENT COMMITTEES

The Club conducting the tournament will appoint for each day a Tournament Committee of three (3) Officials. (See also Australian, State or Territorial Championships.)

- Should any registered caster who is a member of a Tournament Committee wish to participate in any event, they may do so. Should the Tournament Committee be required to adjudicate on any matter arising from this event any member involved therein will stand down and a substitute appointed for those particular disputes.
- The Tournament Committee(s) of the day will decide the direction of casting. At all times courts will be set with any prevailing wind present at that time to be directly behind the casting platform. Such direction may be changed to suit current wind direction but will not be changed during the running of an event. The number of changes will be left to the discretion of the Tournament Committee controlling any of the three Sections, Fly, Weight or Plug.
- Any caster who interferes with the establishment of a court will be disqualified from that event.
- **Protests**
 1. Every caster participating has the right to protest.
 2. Protests have to be delivered in writing to the appropriate Tournament Committee of the day.
 3. Time limit for protests to be lodged is 30 minutes from the end of the event.
- The Tournament Committee will act as an appeals Committee where infringement or interpretation of a Casting Rule or By-Law is in question, should the Tournament Committee find it necessary to defer a decision on such an appeal, it may do so. In such cases it will refer the matter to the Australian Casting Federation for decision.
- The Tournament Committee will take any action, which it deems necessary to prevent distraction of the competitor.
- Any conduct on the part of any competitor, which in the opinion of the Tournament Committee, is unfair or unsporting will be penalised, at its discretion, by disqualification.

JUDGES

- For each court in use, there will be two (2) judges and one (1) scorer drawn from a pool of volunteering **registered casters** and used on a rotational basis during the tournament.
- In all matters of judgement a Judge's decision will be final and cannot be the subject of an appeal.
- Any agency outside the control of the caster, which interferes with his cast or casts, may, at the Judge's discretion, be compensated for by another cast or additional time.

CONDUCT OF AUSTRALIAN, STATE AND TERRITORY CHAMPIONSHIPS

- The Australian, State and Territory Annual Championships will be held as specified by the ACF. The programme of these Tournaments will be determined by the Federation at an Annual General Meeting or at a Special General Meeting of the Federation.
- A minimum of sixty (60) days' notice of all Australian, State or Territory Championship Tournaments is to be relayed to all Affiliated Clubs, Private, Life and Honorary Members. The responsibility for such notice will rest with the ACF Secretary.
- The ACF will determine the Tournament Committees for these Championships.
- Any Section(s) of Championship status, not held at the Annual Championship Tournaments, may be allocated, at the discretion of the Federation, to the Affiliated Club, which applies for them. Any Affiliated Club applying for any Section (Fly, Weight or Plug) of the Australian, State or Territory Championships will provide sufficient officials to conduct the events efficiently.
- If for any reason (climatic etc) the Championships cannot be conducted at the ACF specified venue the ACF may cancel, postpone or relocate the tournament to another suitable location. The Secretary will advise affiliated clubs, private, life and honorary members of the new arrangements.

ENTRIES (AUSTRALIAN, STATE OR TERRITORY CHAMPIONSHIPS)

- All casters must be registered with the ACF to be eligible to compete in Australian, State or Territorial Championships. Territory, State or Australian Records will not be granted to unregistered casters.
- Entries by Registered Casters for all Australian, State or Territory Championships will be in the hands of the ACF Secretary up to fifteen (15) minutes prior to the starting time of the first event on the day of competition.
- Where **Private Membership** is being sought on the same day as the Championships, application forms must be submitted no later than thirty (30) minutes prior to the starting time of the first event on the day of competition.
- The Secretary will check the competitors qualifying performances, and if the entry is in order, forward such entry to the Tournament Committee.
- The names of all entrants in each section of Australian, State or Territory Championships will be placed in a ballot for casting order, and the result of such ballot will carry for all events in that section, and no preference will be given the reigning champions. Each section, Fly, Weight, and Plug, will have its own ballot.
- Entrance fees for Australian, State or Territory events will be as determined by the Federation at an Annual General Meeting or at a Special General Meeting of the Federation.
 - Per Event.
 - Per Group of Events.
 - Per Section (Block Entry for each section of Fly, Weight and Plug).

- Competitors will present themselves within one (1) minute when called to cast. Non-compliance may entail disqualification. Should competitors be unavailable when called owing to participation in another event, judging or scoring at the time, they will present themselves to the judge or scorer as soon as possible; the judge or scorer will then indicate the order in which they are to cast.

GRADINGS FOR AUSTRALIAN, STATE & TERRITORY FLY CASTING CHAMPIONSHIPS

- Casters will be graded according to their recorded **scores in fly accuracy events** over a specified number of nominated tournaments or in any other manner as determined by the ACF.

GRADINGS FOR ACCURACY FLY EVENTS

Grades	Scores
Open (A) GRADE	161 -200
B GRADE	131 -160
C GRADE	101 -130
D GRADE	0 -100

Method of grading

- Casters must submit scores from any 3 ACF sanctioned tournaments (**excluding** National, State or Territory titles) in a 12 months period prior to competing in an Australian, State or Territory Championship. The ACF handicapper will calculate a caster's grade from these three (3) tournaments by the following method:
 1. A caster's **three highest scores** within a given period are used. (i.e. from Aust. Champs. to Aust. Champs.)
 2. **Each one of these three highest scores** must exceed a Grade minimum before a caster moves into the next grade.
 3. Once a caster moves up to a new grade they will not go down a grade.
 4. Where a tournament has four events, the two Skish events are averaged.

QUALIFYING CRITERIA

At Australian, State or Territory Championships ACF registered casters must compete in one of the previously mentioned A, B, C, or D grade categories and qualify in one of the following qualifying criteria.

Qualifying for a grade

"A" Grade Casters

- In order to compete, an A grade caster is required to submit scores from any three (3) ACF sanctioned tournaments from a twelve (12) months period prior to a championship. National, State, or Territory Champions are not included in the three (3) sanctioned tournaments but scores will be used for grading purposes.
- If a caster pays and commences in a qualifying recognised, sanctioned tournament but fails to complete for any reason they will be recognised for qualifying purposes only.
- If an A grade caster fails to submit three scores in a twelve (12) months period prior to a championship **they will not be permitted to compete or cast.**
- If for some reason an A grade caster is unable to submit scores from any three (3) ACF sanctioned tournaments from a twelve (12) months period prior to a championship and **wishes to compete**, they will need to seek permission from the ACF committee no later than fourteen (14) days prior to the championships. The committee will then consider the merits of any reason(s) presented.

“B”, “C”, or “D” Grade Casters

- In order to compete, B, C, or D grade casters are required to submit scores from three (3) ACF sanctioned tournaments from a twelve (12) months period prior to a championship. National, State, or Territory Champions are not included in the three (3) sanctioned tournaments but scores from these championships will be used for grading purposes.
- If a caster pays and commences in a tournament but fails to complete for any reason they will be recognised for qualifying purposes only.
- If a B, C, or D grade casters fails to submit three scores to maintain their grade in a twelve (12) months period prior to a championship then **they will be required to compete in the grade above their current standing.**

I.e.

- D grade will be required to compete in C grade.
- C grade will be required to compete in B grade.
- B grade will be required to compete in A Open grade.

- If for some reason a B, C, or D grade caster is unable to submit scores from three (3) ACF sanctioned tournaments from a twelve (12) months period prior to a championship and wishes to compete in their **current grade** they will need to seek permission from the ACF committee no later than fourteen (14) days prior to the championships. The committee will then consider the merit of any reason(s) presented.

Ungraded Casters

- Being an unknown quantity, any ungraded caster will be obliged to compete in the A grade or Open Section until such time they have achieved an ACF grading.

CHAMPION OF CHAMPIONS

- Australian, State and Territorial Championship Tournaments will be made into three distinct sections:

Section	1 Fly
Section	2 Weight
Section	3 Plug

- Each section will have its own “Champion of Champion” plus in Section 1, Fly Accuracy, ‘B’, ‘C’ and ‘D’ Grade Champions. A minimum of one (1) caster shall constitute a grade in ‘B’, ‘C’ and ‘D’ grades.
- Weight and plug sections will have their own Champion of Champions plus grade Champions if applicable.

SCORING METHOD

- All scores in Sanctioned Tournaments will be recorded on the Official Score Sheets for that particular event. These score sheets are procurable from the Secretary.
- The official score sheets regarding Championship Tournaments will be forwarded by the to the ACF Secretary within fourteen (14) days of the Tournament.
- The competitors score will be determined as follows:

Fly Accuracy Events

- The sum total of each competitors points cast in all their accuracy events will become their Championship Points.

Fly Distance Events

- The winner of each event will receive 100 Championship points and all other competitors Championship points will be determined by dividing their own points cast by the winners points cast and multiplying that result by 100 taken to two decimal places:

eg	Competitor	Cast Points	Championship Points
	1	97	100.00
	2	83	85.56
	3	25	25.77
	4	94	96.90

- The competitor registering the highest total Championship points will be the winner.
- A caster cannot be awarded Championship points for any event in which he has not registered a score.

-

SECTION CHAMPION OF CHAMPIONS

- The Champion of Champions for each section will be determined by adding a caster's sum total accuracy Championship points cast to their distance Championship points.
- A minimum number of four (4) casters must compete **in each event** in a section for National, State or territory Titles before points are awarded for Champion of Champions for that section.

OVERALL CHAMPION OF CHAMPIONS

- An Australian Champion of Champions Trophy will be awarded, encompassing the three different sections of Fly, Weight and Plug of the ACF.
- Unless the three (3) sections are completed in any one Championship calendar year the Overall Champion of Champions trophy will not be awarded.
- Scoring will be the sum of the casters Champion of Champions points for all three sections (Fly, Weight and Plug).

TIES

- A tie is a tie at all times, medallions and certificates will be awarded to all participants involved in the tie.

TOURNAMENT TROPHIES AND CERTIFICATES

- All Australian, State or Territory Championship Perpetual Trophies will become and remain the property of the Federation, and must be surrendered as and when required by the Federation. All expenses for packing and freight in forwarding and returning any trophy will be paid for by the holder of such trophy, but the Federation will arrange and pay for necessary insurance.
- Winners of Australian, State or Territory Championship Events will be presented with a Championship Medallion and Certificate by the Federation. Championship Certificates will also be presented to 2nd and 3rd place getters in Australian, State or Territory Championship Events.
- A minimum number of four (4) casters must compete in **any one (1) event** before Medallions or Certificates are awarded.
- The Certificate and procurement of Championship Medallions will be the responsibility of the Federation.
- ACF Certificates, both Record and Championship are procurable from the Secretary.

INTERNATIONAL CASTERS

- In the event of an International Caster winning a Champion of Champions trophy; the said trophy will not leave Australia, but is held in custody by the Club that the caster is affiliated with, or in the case of the International caster being a Private Member, the trophy will be held in custody by the ACF.

BRUNN SHIELD CLUB TEAMS' EVENT

- The Brunn Shield will be a teams' tournament of ACF affiliated clubs to be contested annually on dates as determined by the ACF.
- The names of all team members will be lodged with the host team before the commencement of each round of the competition and all casters participating in each round will be ACF Registered Casters.
- The tournament will be conducted over four rounds of three events, Dry Fly, Skish, and Wet Fly, with the Skish alternating between and ICF.
- All teams throughout Australia will compete each round on the same day. (See below)
- Clubs which can only cast at their respective venue on a negotiated day with the casting pool landlord, shall be able to cast their Brunn shield rounds on the negotiated day the pool has been hired.
The club must apply to the ACF in writing prior to the first round of the Brunn to conduct the Brunn on each alternative date for the year in question.
- For the first three rounds registered casters will be able to compete for their club at any regional or city venue where a Brunn Shield round is being conducted. The final round will be conducted at a venue determined by the ACF. For all clubs outside Victoria each club may cast at their own respective venue.
- Aggregate points will be accrued over the four rounds taking the four top scores of each team for each event.

The team receiving the highest number of aggregate points at the conclusion of the fourth round will be the winner. Should a draw persist at the conclusion of the competition, a tie will be a tie at all times.

- The Federation will determine the events to be cast. The manner of conducting these events will be determined by the Tournament Committee chosen by the host club of the day.
- Host clubs will be selected as determined by the ACF Committee.
- The ACF will award the highest scoring caster of each round a suitable trophy.
- At the end of the fourth round the ACF will award for 12 months a perpetual trophy to a graded caster from C and D Grades who has accrued the highest aggregate points. A caster may receive this award only once.

RECORDS

- Australian, State or Territory records will not be granted to unregistered casters.
- The ACF will recognise two (2) classes of records.

These will be as follows:

1. Australian
 2. State or Territory
- Records may only be created or equalled in Open events carrying Championship status and at Tournaments conducted by and/or sanctioned by the Australian Casting Federation.
 - Records broken or equalled during the running of the Australian, State or Territory Championships or Tournaments sanctioned by the Australian Casting Federation will be recognised as both Australian and State or Territory records.
 - Scores made in a "Cast Off" are not eligible for record purposes. Other than for fixed measurement events the court is to be reset to different measurements for a cast off.

BREAK RECORDS

- Accuracy break records must be broken by at least one (1) point to create a new record. Equal break records will be recognised.
- All record claims will be made on the official Record Claim form in triplicate as supplied by the Federation.
- When a record is made the officiating judge will submit the tackle to the Tournament Committee as soon as the caster has completed the event.
- Should any records be assumed to have been made, it will be the duty of the Tournament Committee to complete the appropriate sections of the Record Claim Form and to forward or deliver within the specified time one copy to the Claimant and the Federation Secretary.
- The Claimant will sign his copy in the space and then should forward this copy to the Federation Secretary within thirty (30) days.
- The Tournament Committee will within thirty (30) days forward its copy to the Federation Secretary who will arrange for the completion of the remaining section and retain this copy for record purposes.
- The Federation Secretary, on receipt of either copy of a record claim form which has been duly completed will, within forty four (44) days of the score being made, ascertain whether this performance should be recognised as an Australian, State or Territorial Record and if so, with the approval of the Federation President it will be recorded and acknowledged by the issue of an official "Record Certificate".
- Where the rules of this Federation allow an event to be cast on either land or water (eg. 3/8 oz. plug accuracy), records must be kept separately and recognition granted accordingly.
- Procurement of all Claim Forms and Record Certificates will be the responsibility of the Federation.

EVENTS RECOGNISED BY THE ACF AS BEING OF CHAMPIONSHIP STATUS

THE EVENTS LISTED BELOW ARE COMPULSORY FOR AUSTRALIAN CHAMPIONSHIPS IN EACH SECTION

• SECTION 1 – FLY EVENTS

- 1 I.C.F. Skish Fly Accuracy
- 2 Australian Dry Fly Accuracy
- 3 Australian Wet Fly Accuracy
- 4 I.C.F. Fisherman's Accuracy & Distance
- 5 I.C.F. Single Handed Distance
- 6 I.C.F. Double Handed Distance

• SECTION 2 – WEIGHT EVENTS

- 21 Artificial Bait Accuracy 40 points
- 22 Artificial Bait Distance 107 M
- 23 Surf Spinner Distance 130 M
- 24 113 grams Level Line Distance. 122 M
- 25 57 grams Level Line Distance Multiplier 98 M
- 26 57 grams Level Line Distance Fixed Spool 98 M

• SECTION 3 – PLUG EVENTS

- 41 Arenberg (F/S)
- 42 7.5g Skish Plug (F/S)
- 43 18g Skish Plug (R/D)
- 44 7.5g Single Handed Distance (F/S)
- 45 18g Double Handed Distance (F/S)
- 46 18g Double Handed Distance (R/D)

OTHER EVENTS SANCTIONED BY THE ACF BUT NOT OF CHAMPIONSHIP STATUS:

• FLY EVENTS

- 7 Australian Skish Fly
- 8 Australian Fisherman's Accuracy & Distance (DELETED)

• PLUG EVENTS

- 47 3/8oz (10.631g) Level Line Distance
- 48 3/8oz (10.631g) Skish Plug Accuracy (F/S)
- 49 3/8oz (10.631g) Accuracy (R/D)
- 49 5/8oz (17.718g) Accuracy (R/D)

CASTING RULES

RULES ALTERATION

Fly Section

(a) **As per the ACF Statement of Purpose 24.6**

(b) Any alteration to Casting Rules will come into force at the beginning of the next casting season.

(c) The Federation will ensure that any alterations will remain in force for a period of not less than two (2) years.

Weight and Plug Sections

To change ACF Weight and or Plug casting rules

ACF registered caster and life members proposals and voting

Who is entitled to propose & vote on Weight and or Plug Casting Rule alterations?

- Only ACF Registered Casters and Life Members may put forward and vote upon casting rule proposals.
- Each Registered Caster and Life Member will be entitled to one (1) vote only.

How do Registered Casters and Life Members propose Casting Rule alterations?

- Registered Casters and Life Members may submit proposals in person, or by mail.
- Proposals must be in the hands of the ACF Secretary seven (7) days prior to any General Meeting of the ACF.
- Late proposals will be carried over to the next General Meeting.
- Each proposal must carry the name of an ACF Registered Caster or Life Member as a seconder.
- All proposals put to ACF Registered Casters and Life Members for a vote will carry both the name of the proposer and seconder.

How are proposals considered?

- At the ACF General Meeting, the ACF Committee, Life Members and ACF club delegates present will determine which proposals are suitable to be put to ACF Registered Casters and Life Members.
- The proposer of any unsuitable proposal will be advised to take same to his/ her affiliated club for discussion.
- All suitable proposals will be formatted, collated and printed on an official ACF Rule Voting Form (RVF)
- Any duplicated proposal will carry the names of all proposers and seconders.

How are Registered Casters and Life Members advised of proposals?

- A list of all proposals which will include the names of the proposer(s) and seconder(s), along with a Rule Voting Form will be forwarded to each ACF Registered Weight and or Plug Caster.

•

How do Registered Casters and Life Members vote on proposals?

- Registered Casters and Life Members may vote in person, or by mail.

- ACF Registered Casters and Life Members will have until 7 days before the next ACF scheduled General Meeting to return voting forms or may vote in person at the scheduled Meeting.
- The ACF Registered Caster and Life Member will not be obliged to record his/ her name on the voting form.

When will the outcome of voting be announced?

- A count of votes will take place during the ACF General Meeting and an outcome will be announced in the Delegate Report.

How will the alterations be enforced?

- ACF will alter Weight and or Plug casting rules as determined by Registered Casters and Life Members.
 - Any alteration to Plug and or Weight casting rules will come into force at the next ACF Sanctioned Tournament.
 - ACF to ensure that any alterations will remain in force for a period of no less than two (2) years.
-

INTERPRETATION

Where the By-Laws, Casting Rules or Terminology of the Australian Casting Federation are inconsistent with those of the International Casting Federation, the By-Laws, Casting Rules or Terminology of the Australian Casting Federation shall take preference.

SECTION 1 – FLY

ACCURACY FLY

GENERAL RULES

- 1 According to the specific rules for each event, the fly rod must be held in one hand except for Double Handed distance events. It is allowed to achieve fulcrum by putting the rod against the underarm, but no fastening to the hand or arm is allowed.

- 2 **A cast is illegal if:**
 - a) The rod is not handled according to the rules.
 - b) The fly or leader is missing on delivery or the leader is found to be less than 1.80 metres. If the leader (with fly) is tangled the cast is legal.
 - c) When any illegal tackle is being used.
 - d) A Tick occurs (that is a fly touching the water in front of the caster inside or outside the target during false casting) to be called no score (or demerits where applicable) immediately by Judges before next false or delivery cast. In a Dry fly round, if a fly is delivered immediately after the call of "no score" due to a tick, such a delivery is also to be called a no score whether in or outside the target. See also 4 Determining results.
 - e) When distance casting the fly lands outside the court.
 - f) If the line is marked, or is measured along the rod by the caster.
 - g) If the fly and a portion of the leader are not in contact with the water at the commencement of each forward movement of the roll cast.

- 3 **Lost fly or leader and Broken Tackle**
 - a) If the fly or leader is lost, the caster may be assisted by one (1) person at a time, to replace the fly or the leader, but time is not stopped. Distances and hits before the incident count. After losing two (2) flies in Accuracy or (3 flies in FAD.) the caster has to stop casting that event.

If however the hackle of the fly has separated from the hook, subject to the judge's decision, time is stopped, and the caster or his assistant may put on an extra fly. Such changing of the fly is not counted in the restricted number of flies for that event. Time starts again as soon as the fly has been replaced.
 - b) Broken tackle refers only to the rod – not to any other equipment.
 - c) Assistance, from one person at a time, is allowed in order to stretch out the line or clear a tangled line.

4 **Determining results**

a) A delivery cast in accuracy casting which hits either on or in the target area is scored as a hit within the target. **The fly must be left in place until the judge calls a score.**

b) Dry Fly rounds

During false casting to the first target the fly shall not touch or tick the water in front of the caster either inside or outside the target, if it does so the judge shall call time on and a no score is to be recorded.

c) Australian Wet Fly

During false casting to the first target the fly shall not touch or tick the water in front of the caster either inside or outside the target. Penalty for doing so shall be 3 DEMERITS for each touch or tick that occurs. Time on is called when the fly first touches the water.

d) Skish Wet Fly rounds (Measuring cast)

During false casting for the measuring cast to the required target, the fly shall not touch or tick the water in front of the caster either inside or outside the target, if it does so the judge shall call time on and deem it to be the measuring cast, requiring the caster's next cast to be the delivery cast.

5 **Fly**

Standard tournament flies, size 10, tied Palmer pattern or conventional dry fly pattern, with hackle diameter 16 - 22 mm. any colour. In all Dry fly events, the fly is required to float and may be treated with floatant.

6 **Skip Fly**

A fly which first lands outside the target then skips in is an illegal cast and scored accordingly (no score), but if the fly lands inside the target and skips out it is a legal scoring cast.

7 **Platform and or Casting Box**

Where a casting platform is permitted the maximum height above the ground or water shall not exceed 0.5 metres. The casting area (casting box) of 1.2 metres square shall be marked accordingly and the caster must keep BOTH feet inside this area. Where the casting area (casting box) is marked with lines or a mat, the outer edge of the lines or mat shall be the maximum area. If the platform is exactly 1.2 metres square no part of the caster's feet shall overhang the platform.

8 **Judging**

It is the responsibility of the judge to call out the scores clearly and as quickly as possible.

It is the responsibility of the check judge to assist the judge in any way the judge requests, but must also watch and call any "tick" immediately if missed by the judge.

The check judge can only comment on the result of a cast if the judge calls "check".

If time is called BEFORE a fly lands in a target the judge will count it as a non-score.

ACCURACY FLY EVENTS

AUSTRALIAN DRY FLY ACCURACY [Click here for court diagram](#)

Rod

Ordinary fishing rod of maximum length 3.00 metres. Standard fly rod rings or guides.

Reel

Standard fly fishing reel, or self made reel corresponding to standard. Reel fastened to the rod, line fastened to the reel.

Line

Standard fly fishing line or similar line, minimum length 15.00 metres. Backing unrestricted. Metal inlays prohibited.

Leader

Minimum length 1.80 metres. The tippet diameter and length are optional

Fly

Standard tournament flies, size 10, tied Palmer or conventional dry fly pattern, hackle diameter 16 - 22 mm. any colour.

Platform

The platform is to be a minimum of 1.20 metres square. Where the casting area (casting box) is marked with lines or a mat, the outer edge of the lines or mat shall be the maximum area. BOTH feet must be kept inside this area.

Maximum 0.50 metres above the surface of the water.

Placement of targets

Targets shall be placed as follows:

Target one at between 6.10 and 7.60 metres (20 - 25 feet) from the front of the casting box.

Target three between 13.70 and 15.25 metres (45 - 50 feet) from the front of the casting box.

Three more to be scattered at intervening distance in such a manner as to result in an open formation.

Two targets (1 and 3) are measured and the measurements made known to all competitors, with the other three unmeasured targets scattered to create an open formation and when multiple courts are required, any other court will be set in similar fashion to replicate the first court as close as possible – without measuring the three scattered targets.

Counting clockwise, starting with target closest to casting platform, (target No. 1); target No. 5 not to be closer to centre front of casting platform than target No. 1.

The distances of targets 1 and 3 will be

Method of casting

- 1 Caster must start with fly in hand and one (1) rod length of fly line (plus the leader) out through the rod tip.
- 2 Casting shall be single-handed from the casting platform to each target as designated by the judge. Such order shall be maintained throughout the event.
- 3 It shall be the duty of the judge to indicate to the competitor each target in turn if the competitor so wishes.
- 4 At least one false cast shall be made between each try. If no false cast is made then the next try shall be non-scoring.
- 5 Fly shall not touch or tick the water in front of the caster while he is false casting. Penalty for such "tick" shall be no score and shall be regarded as an attempt at the target.
- 6 Three (3) successive tries shall be made at each target in order as called by the judge.
- 7 A hit on the actual target or circle is scored as a hit on the target area inside the target.

Scoring

At each target the score shall be as follows:

- 1st try perfect 5 points.
- 2nd try perfect 3 points.
- 3rd try perfect 2 points.

Maximum Dry Fly score 50 points.

Time

Time allowed shall be 3 minutes commencing when the fly first touches the water

AUSTRALIAN SKISH FLY ACCURACY [Click here for court diagram](#)

This ACF Event shall comprise: (a) **Dry Fly Round**
(b) **Roll Cast Round**
(c) **Wet Fly Round**

Rod

Ordinary fishing rod of maximum length 3.00 metres. Standard fly rod rings or guides.

Reel

Standard fly fishing reel, or self made reel corresponding to standard. Reel fastened to the rod, line fastened to the reel.

Line

Standard fly fishing line or similar line, minimum length 15.00 metres. Backing unrestricted. Metal inlays prohibited.

Leader

Minimum length 1.80 metres. The tippet diameter and length are optional

Fly

Standard tournament flies, size 10, tied Palmer or conventional dry fly pattern, hackle diameter 16 - 22 mm. any colour.

Platform

The platform is to be a minimum of 1.20 Metres Square. Where the casting area (casting Box) is marked with lines or a mat, the outer edge of the lines or mat shall be the maximum area. BOTH feet must be kept inside this area.

Maximum **0.50 metres above the surface of the water.**

Placement of targets

Targets shall be placed as follows:

Target one at between 6.10 and 7.60 metres (20 - 25 feet) from the front of the casting box.

Target three between 12.25 and 13.75 metres (40 - 45 feet) from the front of the casting box.

Three more to be scattered at intervening distance in such a manner as to result in an open formation.

Two targets (1 and 3) are measured and the measurements made known to all competitors, with the other three unmeasured targets scattered to create an open formation and when multiple courts are required, any other court will be set in similar fashion to replicate the first court as close as possible – without measuring the three scattered targets.

Counting clockwise, starting with target closest to casting platform, (target No. 1); target No. 5 not to be closer to centre front of casting platform than target No. 1

FIRST. DRY FLY ROUND

- 1 Caster must start with fly in hand and one (1) rod length of fly line (plus the leader) out through the rod tip.
- 2 Casting shall be single-handed from the casting platform to each target as designated by the judge. Such order shall be maintained throughout the event.
- 3 It shall be the duty of the judge to indicate to the competitor each target in turn if the competitor so wishes.
- 4 At least one false cast shall be made between each try. If no false cast is made then the next try shall be non-scoring.
- 5 Fly shall not touch or tick the water in front of the caster either outside or inside the target while he is false casting. Penalty for such "tick" shall be no score and time on called.
- 6 Three (3) successive tries shall be made at each target in order as called by the judge.
- 7 A hit on the actual target or circle is scored as a hit on the target area inside the target.

Time

Time allowed for this round 2 minutes 30 seconds commencing when the fly first touches the water.

Dry Fly Scoring

Scoring at each target shall be as follows:

1st try, proper hit 5 points

2nd try, proper hit 3 points

3rd try, proper hit 2 points

Maximum Dry Fly score 50 points.

SECOND. ROLL or SWITCH CAST ROUND

Definition of Roll Cast (or Switch Cast)

Roll Cast is casting the fly by means of rolling the line across the water with the rod in a vertical or upright position. Switch Cast is with rod in a side or horizontal cast position.

A legitimate Roll (or Switch) cast

At the commencement of the forward movement of the rod to implement or execute the roll cast, the fly and part of the leader **MUST** still be on or in contact with the water; otherwise the cast is deemed to be illegal.

To begin, the caster rolls or switch casts from the last dry fly target to the target nearest the casting platform on the left side, and rolls or switch casts until 2 hits are scored. The caster then proceeds to the next target to the right and so on in clockwise order 1 - 2 - 3 - 4 - 5 until all five (5) targets are scored twice, or the judge calls time.

Time

Time allowed shall be 1 minute 30 seconds commencing when the fly first touches the water.

Roll Cast Scoring

The score shall be five points for each target hit made up as:

First hit 3 points

Second hit 2 points

Maximum Roll Cast score 25 points.

THIRD. WET FLY ROUND

- 1 Competitors need not rewind their line onto the reel but must still prepare to cast with fly in hand and one rod length of fly line out of the rod tip plus the leader, no loops of fly line are to be retained in hand.
- 2 The line shall be extended to the nearest target by false casting. If the fly should "tick" the water it shall be deemed the measuring cast and the fly must be put down in the first ring on the **NEXT** cast to record a score. No false casting is permitted following the measuring cast. . If the line is false cast instead of being delivered it is "no score" for every false cast and the next target changes accordingly.
- 3 If no "tick" the first try shall be a measuring cast and shall not score but **must be completed within one minute of the finishing cast in the roll.**
- 4 The competitor shall then make two (2) tries at this target, and then proceed in clockwise order to the next target, and so on to all targets.
- 5 At no time after the measuring cast shall false casting be allowed. Each false cast shall be scored as a no score cast.

Time

The time allowed shall be 1 minute 30 seconds commencing when the fly first touches the water.

Wet Fly Scoring

Scoring for this round shall be as follows:

1st try perfect 3 points

2nd try perfect 2 points

Maximum Wet Fly score 25 points.

Highest possible score in the ACF Skish Fly Accuracy 100 points.

That in any WET FLY AUSTRALIAN ACF Skish where a caster has stopped casting because of outside interference or the loss of a fly and is then to recommence casting within the allotted time, their fly line be straightened out behind them so that **one only** false forward cast and **one only** back cast be permitted in order to load the rod before delivering the fly to the appropriate target on the next forward cast.

Penalty for exceeding the allotted forward cast and back cast shall be no score for each non-permitted false cast in either direction.

If the fly ticks the water in front of the caster will be a no score.

AFFECTS UPON SCORING

Exceeding allotted false casts

A no score shall be called and recorded for each non-permitted false cast, therefore a delivery hit in a correct target shall be awarded the next lower score down, provided the fly has previously not ticked the water.

Ticking the water on the allotted false cast

A no score shall be called and recorded if the fly ticks the water on the allotted false cast, therefore a delivery hit in a correct target shall be awarded the next lower score down

Where a caster exceeds the permitted false casts and also ticks the water, no scores shall be called and recorded with the total of these no scores affecting downwards a delivery hit score in a correct target.

I.C.F. SKISH FLY ACCURACY [Click here for court diagram](#)

This ICF Event shall comprise: (a) **Dry Fly Round**
(b) **Roll Cast Round** (excluded when cast on land)
(c) **Wet Fly Round**

Rod

Ordinary fishing rod of maximum length 3.00 metres. Standard fly rod rings or guides.

Reel

Standard fly fishing reel, or self made reel corresponding to standard. Reel fastened to the rod, line fastened to the reel.

Line

Standard fly fishing line or similar line, minimum length 15.00 metres. Backing unrestricted. Metal inlays prohibited.

Leader

Land

Minimum length 1.80 metres. The **tippet** diameter and length are optional.

Water or plastic pool

Minimum length 1.80 metres. The **tippet** shall be no shorter than the minimum length of 20cm and must be able to pass through a gauge set to 0.25mm.

Fly

Standard tournament flies, size 10, tied Palmer or conventional dry fly pattern, hackle diameter 16 - 22 mm. any colour.

Platform

Land

The platform is to be a minimum 1.2 metres square. Where the casting area (casting Box) is marked with lines or a mat, the outer edge of the lines or mat shall be the maximum area. BOTH feet must be kept inside this area.

Maximum 0.50 metres high from the ground.

Water or plastic pool

The platform is to be a minimum of 1.20 metres square. Where the casting area (casting Box) is marked with lines or a mat, the outer edge of the lines or mat shall be the maximum area. BOTH feet must be kept inside this area.

Maximum 0.50 metres above the surface of the water.

Placing of Targets

Land

5 hollow disks, 0.76 metres diameter, made from plastic or metal, with turned-up edge 3cm high. Colour black, dark green, blue or brown. Disk No.1 to the left of the caster, 8 metres from the front edge of the platform, disk No. 5 to the right 13 metres from the front edge of the platform. Disks No's. 2, 3 and 4 in a straight line between No's. 1 and 5. Disk No.3 always placed directly in front of the platform. Distance between the centres of the targets to be 1.80 metres, all distances to be measured from the centre of the Front of the platform and the centre of the targets.

Water or Plastic Pool

5 ring 0.76 metres in diameter. No. 1 to be placed at 8 metres and No. 5 at 13 metres from the centre of the targets to the centre point of the front of the platform or casting box. The nearest target to the left of the caster; the farthest to the right, and the rest at increasing intervals from the casting box. Target number 3 always placed directly in front of platform. Surface free water between the targets shall be at or between the minimum of 1.2 metres or maximum of 1.5 metres.

FIRST. DRY FLY ROUND

Caster must start with fly in hand and one (1) rod length of fly line (plus the leader) out through the rod tip. Dry fly casting one try at a time on each target in the following order:

3 - 1 - 4 - 2 - 5 - 3 - 1 - 4 - 2 - 5

At least one false cast shall be made between each score or lay of the fly. All ten targets to be cast to in the consecutive order given, or as many as time permits. The fly line may only be shortened or lengthened during false casting, with the rod in motion. No stripping of the line from the reel when the rod is not in casting motion. Improper stripping or shortening of the line shall make the next cast non-scoring.

Competitor, on completing Final try of Dry Fly round, shall leave fly floating on the water in order to commence the Roll Cast round.

Time

3 minutes and 30 seconds, time to begin when the fly hits the surface, in or outside the target for the first time. Last cast to be finished and fly to hit the surface before time expires.

Dry Fly Scores

Land

Each hit in or on the target scores 6 points.

Maximum score Dry Fly round on land 60 points.

Water or Plastic Pool

Each hit in or on target scores 5 points. Fly should rest on the water until the judge calls score.

Ticks count as tries but are non-scoring. Maximum score Dry Fly round 50 points. (Ticks to be called immediately before next false or delivery cast is completed.)

SECOND. ROLL or SWITCH CAST ROUND (on water or plastic pool)

Definition of Roll Cast (or Switch Cast)

Roll Cast is casting the fly by means of rolling the line across the water with the rod in a vertical or upright position. Switch Cast is with rod in a side or horizontal cast position.

A legitimate Roll (or Switch) cast

At the commencement of the forward movement of the rod to implement or execute the roll cast, the fly and part of the leader **MUST** still be on or in contact with the water; otherwise the cast is deemed to be illegal.

To begin, the caster rolls or switch casts from the last dry fly target to the target nearest the casting platform on the left side, and rolls or switch casts until 2 hits are scored. The caster then proceeds to the next target to the right and so on in clockwise order 1 - 2 - 3 - 4 - 5 until all five (5) targets are scored twice, or the judge calls time.

Time

Time limit 1 minute 30 seconds commencing when the fly first touches the water.

Roll Cast Scores

Each first hit scores 3 points; each second hit scores 2 points.

Maximum Roll Cast score 25 points.

THIRD. WET FLY ROUND

Having completed his Dry fly round of casting on land, or his Roll casting round on water or plastic pool, the caster need not rewind the line onto the reel; no loops of fly line are to be retained in hand. Caster must start with fly in hand and one (1) rod length of fly line (plus the leader) through the rod tip for the Wet fly round with a measuring cast to target No.1, extending line as required with false casting only. During such false casting, the fly shall not touch or tick the water in front of the caster. If the fly should "tick" the water this shall be deemed the measuring cast and the fly must be put down in the first ring on the NEXT cast to record a score. If the line is false cast instead of being delivered it is "no score" for every false cast and the next target changes accordingly.

Eg. If a "tick" occurs and the fly is not put down, but is false cast twice the caster would receive 2 "no scores" and his next target would be No. 3.

The measuring cast to be made within 1 minute from finishing last cast in the roll cast. When finished with the measuring cast the caster makes one Wet fly cast at a time to each target in consecutive order 1 - 2 - 3 - 4 - 5 - 1 - 2 - 3 - 4 - 5. Line may be pulled in to shorten length between targets No's. 5 and 1, but should the fly leave the water whilst retrieving line between targets No. 5 and No. 1, it will count as "No Score" and the caster will proceed to No. 2 target. 10 wet fly casts in all.

Time

Time limit 1 minute. Time begins when fly strikes the water for the first time.

That in any WET FLY ICF Skish where a caster has stopped casting because of outside interference or the loss of a fly and is then to recommence casting within the allotted time, their fly line be straightened out behind them so that **one only** false forward cast and **one only** back cast be permitted in order to load the rod before delivering the fly to the appropriate target on the next forward cast.

Penalty for exceeding the allotted forward cast and back cast shall be no score for each non-permitted false cast in either direction.

If the fly ticks the water in front of the caster will be a no score.

AFFECTS UPON SCORING

Exceeding allotted false casts

A no score shall be called and recorded for each non-permitted false cast, therefore a delivery hit in a correct target shall be awarded the next lower score down, provided the fly has previously not ticked the water.

Ticking the water on the allotted false cast

A no score shall be called and recorded if the fly ticks the water on the allotted false cast, therefore a delivery hit in a correct target shall be awarded the next lower score down.

Where a caster exceeds the permitted false casts and also ticks the water, no scores shall be called and recorded with the total of these no scores affecting downwards a delivery hit score in a correct target.

Wet Fly Scores

On Land

Each proper hit both first and second rounds scores 4 points.

Maximum Wet Fly score 40 points.

On Water or plastic pool

Each proper hit first round scores 3 points.

Each proper hit second round scores 2 points.

Maximum Wet Fly score 25 points.

Highest possible score in the ICF Skish Fly Accuracy 100 points.

AUSTRALIAN WET FLY ACCURACY [Click here for court diagram](#)

Rod

Ordinary fishing rod of maximum length 3.00 metres. Standard fly rod rings or guides.

Reel

Standard fly fishing reel, or self made reel corresponding to standard. Reel fastened to the rod, line fastened to the reel.

Line

Standard fly fishing line or similar line, minimum length 15.00 metres. Backing unrestricted. Metal inlays prohibited.

Leader

Minimum length 1.80 metres. The tippet diameter and length are optional

Fly

Standard tournament flies, size 10, tied Palmer or conventional dry fly pattern, hackle diameter 16 - 22 mm. any colour.

Platform

The platform is to be a minimum of 1.20 Metres Square. Where the casting area (casting Box) is marked with lines or a mat, the outer edge of the lines or mat shall be the maximum area. BOTH feet must be kept inside this area.

Maximum 0.50 metres above the surface of the water.

Placing of targets

Five targets shall be connected together in a straight line at 1.5 metre centre-to-centre intervals. The centre of the nearest target shall be 10.75 metres from the front edge of the casting platform.

Method of casting

- 1 Caster must start with fly in hand and one (1) rod length of fly line (plus the leader) out through the rod tip.
- 2 Casting shall be single-handed from the casting platform to each target.
- 3 The line shall be extended to the first target by false casting.
- 4 During such false casting the fly shall not touch or tick the water in front of the caster. Penalty for doing so shall be 3 DEMERITS for each touch or tick that occurs.
- 5 There shall be no measuring cast.
- 6 No false casts shall be allowed after the first delivery cast. If such occurs penalty shall be a no score cast for each false cast.
- 7 Three attempts shall be made in succession at each target, commencing with the first target.
- 8 The fly may be extended or shortened on the water.

Scoring

At each target the score shall be as follows:

1st try perfect 5 points.

2nd try perfect 3 points.

3rd try perfect 2 points.

Maximum Wet Fly score 50 points.

Time

Time allowed shall be 3 minutes commencing when the fly first touches the water.

That in any AUSTRALIAN WET FLY ACCURACY where a caster has stopped casting because of outside interference or the loss of a fly and is then to recommence casting within the allotted time, their fly line be straightened out behind them so that **one only** false forward cast and **one only** back cast be permitted in order to load the rod before delivering the fly to the appropriate target on the next forward cast.

Penalty for exceeding the allotted forward cast and back cast shall be no score for each non-permitted false cast in either direction.

If the fly ticks the water in front of the caster will be a no score.

AFFECTS UPON SCORING

Exceeding allotted false casts

A no score shall be called and recorded for each non-permitted false cast, therefore a delivery hit in a correct target shall be awarded the next lower score down, provided the fly has previously not ticked the water.

Ticking the water on the allotted false cast

A no score shall be called and recorded if the fly ticks the water on the allotted false cast, therefore a delivery hit in a correct target shall be awarded the next lower score down.

Where a caster exceeds the permitted false casts and also ticks the water, no scores shall be called and recorded with the total of these no scores affecting downwards a delivery hit score in a correct target.

DISTANCE FLY

GENERAL RULES

- 1 According to the specific rules for each event, the fly rod must be held in one hand except for Double Handed distance events. It is allowed to achieve fulcrum by putting the rod against the underarm, but no fastening to the hand or arm is allowed.
- 2 **A cast is illegal if:**
 - a) The rod is not handled according to the rules.
 - b) The fly or leader is missing on delivery or the leader is found to be less than 1.80 metres.
 - c) When any illegal tackle is being used.
 - d) When distance casting the fly lands outside the court.
 - e) If the line is marked, or is measured along the rod by the caster.
- 3 **Lost fly or leader and Broken Tackle**
 - a) If the fly or leader is lost, the caster may be assisted by one (1) person at a time, to replace the fly or the leader, but time is not stopped. Distances and hits before the incident count. After losing 3 flies in either the FAD. Single-handed Distance, Double-handed Distance, the caster has to stop casting that event
 - b) If however the hackle of the fly has separated from the hook, subject to the judges' decision, time is stopped, and the caster or his assistant may put on an extra fly. Such changing of the fly is not counted in the restricted number of flies for that event. Time starts again as soon as the fly has been replaced.
 - d) Broken tackle refers only to the rod – not to any other equipment.
 - e) Assistance, from one person at a time, is allowed in order to stretch out the line or clear a tangled line.
- 4 **Determining results**
 - a) A delivery cast in accuracy casting which hits either on or in the target area is scored as a hit within the target. The fly must be left in place until the judge calls a score
- 5 **Fly**

Standard tournament flies:
FAD size 10, tied Palmer or conventional dry fly pattern, hackle diameter 16 - 22 mm. any colour.
Double-handed size 6, tied Palmer pattern, hackle. Any colour.
- 6 **Skip Fly**

A fly which first lands outside the target then skips in is an illegal cast and scored accordingly (no score), but if the fly lands inside the target and skips out it is a legal scoring cast.
- 7 **Platform and or Casting Box**

Where a casting platform is permitted the maximum height above the ground or water shall not exceed 0.5 metres. The casting area (casting box) of 1.2 metres square shall be marked accordingly and the caster must keep BOTH feet inside this area. Where the casting area (casting box) is marked with lines or a mat, the outer edge of the lines or mat shall be the maximum area. If the platform is exactly 1.2 metres square no part of the caster's feet shall overhang the platform.
- 8 **Judging**

It is the responsibility of the judge to call out the scores clearly and as quickly as possible.
It is the responsibility of the check judge to assist the judge in any way the judge requests, but must also watch and call any "tick" immediately if missed by the judge.
The check judge can only comment on the result of a cast if the judge calls "check".
If time is called BEFORE a fly lands in a target the judge will count it as a non-score.

ICF FLY ACCURACY AND DISTANCE (FAD)

Rod

Any fly rod maximum length 3.00 metres. Standard fly rod rings or guides.

Reel

Standard fly fishing reel or self made reel corresponding to that standard. Reel to take complete line and backing and to be fastened to the rod.

Line

Standard fly line. Minimum length 13.00 metres and maximum weight 38 grams for men, minimum 13.00 metres and 34 grams for ladies. Line shall not be marked to measure distance. Metal inlays are prohibited. Backing unrestricted.

Leader

Minimum length 1.80 metres.

Fly

Standard tournament flies, size 10, tied Palmer or conventional dry fly pattern, hackle diameter 16 - 22 mm. any colour.

Platform

Land

The platform is to be a minimum 1.2 metres square. Where the casting area (casting Box) is marked with lines or a mat, the outer edge of the lines or mat shall be the maximum area. BOTH feet must be kept inside this area.

Maximum 0.50 metres high from the ground.

Water or plastic pool

The platform is to be a minimum of 1.20 metres square. Where the casting area (casting Box) is marked with lines or a mat, the outer edge of the lines or mat shall be the maximum area. BOTH feet must be kept inside this area.

Maximum 0.50 metres above the surface of the water.

Targets

Land

3 targets each with 3 concentric rings of respectively 0.60 - 1.20 - 1.80 metres. In the centre a hollow disk of 0.60 metres diameter, 3 cm high, water filled. Disk colour optional. Targets may be of plastic or cloth, colour green, with white circles up to 2cm wide. If hollow tube targets are used maximum tube diameter 2cm. The distance between targets, land and water, to be 3.50 metres from target centre to target centre.

For men

Target No.1 to the left 11.00 metres, target No.2 13.00 metres, target No.3 to the right 15.00 metres, all measured from target centre to the centre point of the front of the casting box.

For ladies

Same as for men but the distances are as follows: 8.00 - 10.00 - 12.00 metres.

3 targets each with 3 concentric hollow tube rings of respectively 0.60 - 1.20 - 1.60 metres.

Water

3 targets each with 3 concentric hollow tube rings of respectively 0.60 - 1.20 - 1.80 metres

For men

The centre of the nearest target, to the left of the caster, shall be between 10.50 and 12.00 metres from the centre of the front edge of the casting box. The centre of the farthest target to the right of the caster between 14.50 and 16.00 metres. The target in the middle to be placed at an unknown distance between the left and the right.

For ladies

The distance to each target to be shortened by 2.00 metres.

CASTING THE ICF, FAD ACCURACY EVENT

Caster must start with fly in hand and one (1) rod length of fly line (plus the leader) out through the rod tip. Casting shall be single-handed from the casting platform to each target.

Nine tries on targets to be made with three casts each round, in the following order.

First round: 1 – 2 – 3. Second round: 2 – 3 – 1. Third round: 3 – 1 – 2. Between each round the caster must reel in line to starting position with fly in hand. Fly line may only be lengthened or shortened during actual false casting. No stripping from the reel allowed before or between casts. When cast on water, ticks count as casts but non-scoring.

Score

From the centre 10 - 6 - 2 points, for hitting respectively inside or on 60 - 120 - 180 cm rings.

Maximum ICF, FAD accuracy score 90 points.

CASTING THE ICF, FAD SINGLE HANDED DISTANCE EVENT

The same tackle must be used for FAD distance as for the FAD accuracy event, an assistant may pull out the line after the accuracy event, but the time continues to run. The same courts and or platforms are to be used for accuracy and distance. .

Court

At 100 metres distance, the court is 50 metres wide, measuring at a right angle to the perpendicular axis from the front centre of the platform.

Score

The two (2) longest distance casts to be added and the sum added to the accuracy score, **with 1 metre = 1 point. Fractions are counted.**

Time

8 consecutive minutes for the ICF, FAD accuracy and FAD distance events in all.

ICF FLY DISTANCE SINGLE HANDED

Rod

Single handed. Maximum length 3.00 metres. Standard fly rod rings or guides.

Reel

Any reel to take complete line and backing and to be fastened to the rod.

Line

Any line of minimum length 13.00 metres and maximum weight 42 grams, in whole or spliced from separate pieces.

Leader

Minimum length 1.80 metres, maximum length 3.60 metres.

Fly

Standard tournament flies, size 10, tied Palmer or conventional dry fly pattern, hackle diameter 16 - 22 mm. any colour.

Platform

Land

The platform is to be a minimum 1.2 metres square. Where the casting area (casting Box) is marked with lines or a mat, the outer edge of the lines or mat shall be the maximum area. BOTH feet must be kept inside this area.

Maximum 0.50 metres high from the ground.

Water or plastic pool

The platform is to be a minimum of 1.20 metres square. Where the casting area (casting box) is marked with lines or a mat, the outer edge of the lines or mat shall be the maximum area. BOTH feet must be kept inside this area.

Maximum 0.50 metres above the surface of the water.

Court

Land

At 100 metres distance, the court is 50 metres wide, measuring at a right angle to the perpendicular axis from the front centre of the platform.

Water

Casting parallel to straight line measuring device either floating in the water or rigged on the bank at 90 degrees to the front of the platform.

Measuring distance

On land, from the centre point of the front edge of the platform.

On water, from the front edge of the platform along the measuring device and at right angles to the Fly.

Score

Average of the casters three **(3)** longest casts to be the casters score, **with 1 metre = 1 point. Fractions are counted.**

Time

5 minutes. The line may be pulled out outside the court during the casting of the previous caster.

ICF FLY DISTANCE DOUBLE HANDED

Rod

Maximum length 5.20 Metres.

Reel

Any reel to take complete line and fastened to the rod.

Line

Any line, maximum weight 120 grams over 15 metres, in whole or spliced from separate bits.

Leader

Maximum length 5.20 Metres.

Fly

Standard tournament flies, size 10, tied Palmer or conventional dry fly pattern, hackle diameter 16 - 22 mm. any colour.

Platform

The platform is to be a minimum 1.2 metres square. Where the casting area (casting box) is marked with lines or a mat, the outer edge of the lines or mat shall be the maximum area. BOTH feet must be kept inside this area.

Maximum 0.50 metres high from the ground.

Court

At 100 metres distance, the court is 50 metres wide, measuring at a right angle to the perpendicular axis from the front centre of the platform.

Measuring Distance

On land, from the centre point of the front edge of the platform or casting box.

On water, from the front edge of the platform or casting Box along the measuring device and at right angles to the Fly.

Score

Average of the casters three (3) longest casts to be the casters score, **with 1 metre = 1 point. Fractions are counted.**

Time

7 minutes. The line may be pulled out outside the court during the casting of the previous caster.

SECTION 2 – WEIGHT

DISTANCE CASTING.

Field.

- 1 Casting shall be done in a "U" court on an open Field, of which, the grade shall not exceed 300 mm in 30 metres.
- 2 The angle of the court shall measure 25 Metres each side of a centre line at 100 Metres from the apex. Extend the two side lines to 200 metres.
- 3 All casts to be made from ground level, the use of any elevated positions is not allowed. Casting will be done from within a casting box. The box shall have a straight plank 2.50 metres long and 15 mm high in front, at right angles to the centre line of the court extending to both sides of the apex. To each end of this plank is another plank at right angles from it, in a direction away from the court, 1 metre each. The whole box is three (3) sided and open in behind.
- 4 The contestants shall stand behind and clear of the starting plank, and between the ends of the box. The caster having finished his cast has to leave the box through the open back. If the caster oversteps any part of the box, the cast will be counted but not scored.
- 5 All distance casting to be done with the wind. If the wind veers during the casting of an event, the court may be changed after the completion of that event, in the direction of the wind for the next event.
- 6 All weights shall remain in the court to register a score, but also must not be touching the court boundaries at any point.
- 7 No cast to be measured if the weight is still not attached to the line and reel when the weight comes to rest, and all measurements to be made from the apex of the court to where the weight comes to rest.
- 8 All casting, and all mending of gear and repair of tackle must be done without assistance. No tackle to be changed from the time a caster enters the court, with the following exceptions:
 - a) Lines of the same diameter as used.
 - b) Replacement of broken tackle in all events provided this could be accomplished within the given time limits.

Twenty (20) minutes of repair time in all, are allowed each caster for the event. Time for repair starts from the moment the caster should have entered the casting box or appeared in his turn for the cast he is unable to deliver.
- 9 All casters shall have one (1) minute to be present when their time to cast has arrived according to the official program and/or the order of casting. Failure to be present shall result in the caster being disqualified from that round or event.
- 10 Any cast in contravention of these rules shall not be scored, and the caster shall be penalised by the loss of that cast.
- 11 The judge may alter the order of casters when necessary.
- 12 Each cast shall be measured from the apex of the court to the extremity of the casting weight.

Rods.

There is no restriction as to the length, weight, design or material in the construction of rods.

Reels.

There is no restriction as to the type or manufacture of reels.

Lines.

- 1 There is no restriction to the type of material used in the construction of lines.
- 2 Lines for spinner events shall not be less than 0.30mm.
- 3 Doubling of the line at the points of attachment only is permitted.
- 4 In level line and accuracy events, the line shall be of uniform diameter throughout.
- 5 Leaders are permissible in spinner events. Only leaders of monofilament material shall be permitted.

Weights.

- 1 **All weights used are to be of the association standard pattern and shall be supplied by the officials conducting the tournament.**
- 2 If intermediate weights are not available from officials conducting the tournament, the casters may supply and use their own weight, if approved by officials.
- 3 In Australian, Territory and State Championships all weights shall be painted an official colour.
- 4 The weights 113 grams, 57 grams and intermediate weights shall be known as "Weights" and shall be made of lead or lead alloy.
- 5 The tolerance permitted on weights is 2.5% plus or minus of the total weight.

Surf Spinner.

The Surf Spinner shall not exceed 113 grams in weight and shall be substantially of the Association standard pattern.

CONDUCT OF TOURNAMENT FOR WEIGHT SECTION.

- 1 In all distance events each competitor shall be accompanied by a marker, who marks the position of the weight on the court. The furthest point of a weight shall be marked. Only competitors, their markers and Tournament Committee members are allowed on the court during the casting of an event. During the measuring only members of the tournament committee and assistants appointed by the Tournament Committee are permitted on the court.
- 2 In distance casting each competitor shall make three (3) casts, the longest to count. In average distance casting, each competitor shall make three (3) casts and the average of the three shall count.
- 3 A no cast counts as a cast but cannot score.
- 4 A long distance cast record can be made in an average event.
- 5 A break off in an event for an individual average shall prevent a caster from claiming a distance record in that event for any cast made after the "break off", a record cast made before the break off or no cast shall be valid. This penalty shall not apply in teams' events.
- 6 A caster shall have one (1) minute to report to the casting box after being called. All competitors must be ready to make their cast during the round in progress, and if not ready when called by the starter may be disqualified for that round. In no case can a competitor make a cast after the round has been completed.
- 7 All weight distance events shall be cast in rounds (i.e. caster to have one cast before the first participant has his or her second cast).

PENALTIES FOR WEIGHT SECTION.

- 1 A cast is not complete until the lead comes to rest on the ground. A competitor shall at the judge's request, retrieve his line on to his reel, or remove it from the ground to the judge's satisfaction.
- 2 The line must remain unbroken until sinker or weight comes to rest. The competitor must remain behind the base board throughout the entire cast. Penalty for failure, No Cast.
- 3 In all events the weight must come to rest within the confines of the casting court. Penalty for failure, No Cast.
- 4 Every event shall be conducted on rounds and each competitor must make his or her attempt for that round while it is in progress.
- 5 A maximum of one (1) minute is allowed for a caster to be on the casting base after being called.
- 6 The starter may award another attempt where influences outside the competitors control have caused interference with his or her efforts.

ARTIFICIAL BAIT DISTANCE.

This shall be made of dowel 90 mm long and 13 mm diameter with rounded ends. A trace of cord or nylon 525 mm long shall be attached. The casting weight shall not be greater than 113 grams and its trace shall not exceed 50 mm, also it must be free running on the casting line. No leader is permitted and casting line must be level throughout.

ARTIFICIAL BAIT ACCURACY.

Rods.

There is no restriction as to the length, weight, design or material in the construction of rods.

Reels.

There is no restriction as to the type or manufacture.

Line.

Must be level line throughout tip ring or swivel of attachment.

Rig.

Shall consist of a piece of dowel 90 mm long and 13 mm in diameter with rounded ends. It is attached to the main line by a leader to which the distance from the main line to the top of the bait shall be no less than 150 mm. The minimum leader length from main line to weight shall be 525 mm.

Weights.

Weights used shall be not more than 113 grams.

Targets.

- 1 Shall be 380 mm diameter disk of any stiff material fixed onto an upright. The centre of the target shall be no more than 600 mm from ground level.
- 2 The targets shall be painted red, white, blue and yellow and shall be cast for in this sequence irrespective of which distance they may represent.
- 3 The placing of target colour position will be decided by the officials conducting the tournament.
- 4 The scoring tape shall be a 6 Metre tape no more than 75 mm wide, graduated in decreasing intervals of 300 mm from the target and attached to the target by means of a ring at ground level. On 46 Metres target this tape shall be 3 Metres long.

Field Layout.

- 1 The distance of targets shall be 82 Metres, 78 Metres, 69 Metres, and 46 Metres, all distances are to be exact.
- 2 The 82 Metres target to be measured first, placed square on to the centre of the base board, (the line between these two points will be referred to as the centre line). The 69 Metre target to be placed to the right of the centre line. The 78 Metre target to be placed to the left of the centre line. The 46 metre target to be placed between the 69 metre target and the centre line.
- 3 The casting position shall be from a casting box 2.5 Metres square.
- 4 The casting distances are to be measured from the centre of the base board which is the leading edge of the casting box.
- 5 For ladies and juniors the target distances shall be 60 - 50 - 40 - 30 Metres.

Method of Casting.

- 1 The event shall be determined over two (2) rounds of one cast at each target, i.e. eight casts by each caster, unless otherwise stipulated before the start of the event.

Points.

Points scored by a caster in Artificial Bait Accuracy shall be taken from the point of impact of the weight on the ground, not to where it bounces. If the caster strikes any part of the target with the weight, the maximum points for that target shall be awarded. One point shall be awarded for each 300 mm measured on the tape.

Markers.

Three persons shall be selected by officials conducting the tournament to act as markers. Two of these shall mark where the weight lands and the other shall relay to scorer the points scored by each caster. The markers shall stand outside and to the side of the radius of the corresponding target. No marker shall stand directly behind the target. The markers shall signal the "All clear" for a cast to be made and shall stand still while the cast is being made.

SECTION 3 –PLUG

DISTANCE CASTING.

Field.

- 1 Casting shall be done in a "U" court on a open field, of which the grade shall not exceed 300 mm in 30 Metres.
- 2 The angle of the court shall measure 25 Metres each side of a centre line at 100 Metres from the apex.
- 3 All casts shall be made from behind a base board 150 mm high, 2.5 Metres long, firmly secured at the apex of the court at 90 degrees to the centre line.
- 4 All weights must remain in the court to register a score.
- 5 The distance of the casts shall be measured from apex of the court to the furthest extremity of the weight, using a steel tape.
- 6 Flags will be placed on the court in position of current Territory, State and Australian records for that event

Rods.

Rods to be used in all plug events shall be unrestricted as to material or manufacture, they shall be held in one hand only during the cast.

Reels.

There is no restriction to the type or manufacture

Lines.

- 1 There is no restriction to the type of material used in construction of lines.
- 2 Level line distance events the line shall be of uniform diameter throughout. Lines of similar diameter but different manufacture shall not be joined together.

Plugs

- 1 For all Plug distance events the plugs used shall be of the I.C.F. type, made of plastic and as approved by the Australian Casting Federation. The distance plug weights are 18 grams and 7.5 grams.
- 2 For all Plug Accuracy events the plugs used shall be as approved by the ACF the Accuracy plug weights are 18 gram and 7.5 grams.
- 3 Depending on commercial availability the ACF may approve of different types of plugs from time to time.
- 4 The specified weight of all plugs shall be accurate within a tolerance of plus or minus 2.5%.
- 5 All plugs used in ACF events shall be as supplied, (no painting, dying or any other alteration to the plug shall be permitted).

Conduct.

In all distance events each competitor shall be accompanied by a marker, who will mark the position of the plug on the court. The furthest point of a plug shall be marked. Only competitors, their markers and tournament officials are allowed on the court during the casting of an event. During the measuring only members of the tournament committee and assistants appointed by the Tournament Committee are permitted on the court.

Leaders.

Leaders are permitted except where specifically stated otherwise. The term leader is defined as follows.:

A leader is a length of graded material extending from the plug to the main line, and its purpose is to allow the use of a light line main line by taking the initial inertia of the weight of the plug. In all ACF casting events no tail planes of any description shall be permitted

Method.

- 1 In distance casting each competitor shall make three (3) casts, the longest to count. In average distance casting each competitor shall make casts and the average of the three longest shall count.
- 2 A cast is not complete until the plug has come to rest on the ground with the line and leader unbroken. A competitor shall at the judges request, retrieve his or her line onto his or her reel, or remove it from the ground to the judges satisfaction.
- 3 If a caster steps on or over the base line when making his or her cast that cast shall be a "no cast-.
- 4 A "no cast" counts as a cast but does not score.
- 5 A long distance cast record can be made in an average event.
- 6 A break off in an event for an individual average shall prevent a caster from claiming a distance record in that event for any cast made after the break off, a record cast made before the break off or no cast shall be valid. This penalty shall not apply in teams events.
- 7 A caster shall have one (1) minute to report to the casting box after being called. All competitors must be ready to make their cast during the round in progress, and if not ready when called by the starter may be disqualified for that round. In no case can a competitor make a cast after the round has been completed.
- 8 All plug distance events shall be cast in rounds (i.e. all casters to have made one cast before the first participant has his or her second cast.

PLUG ACCURACY CASTING SECTION.

Events.

Events using plugs of 18 grams, and 7.5 grams shall be cast on land.

Rods.

Single handed minimum length 1.37 metres, maximum length 2.50 metres, at least three (3) rod rings and tip ring 10 mm. Handle not to exceed 1/4 of rod length.

Plugs.

Both the 7.5-gram and 18 gram plastic plugs will be drop-shaped with an even surface. The tolerance on weight for the 7.5-gram plug shall be a maximum 0.15 grams including eye. The tolerance on weight for the 18 gram plug shall be a maximum 0.30 grams including eye. Any colour is allowable.

Lines.

Unrestricted, but the same diameter throughout the whole length. Minimum length of 20 metres for 7.5 gram accuracy events and 22 metres for 18 gram accuracy.

Reels.

Reels used in plug accuracy events shall be as follows.:

- a) In Plug Accuracy events 18 grams the reel shall be of the revolving drum type only.
- b) In both Plug Accuracy 7.5 grams events the reel shall be of the fixed spool type only. Both open and closed face types are acceptable.

Definition of reels.

Revolving Drum reels.

Drum axis at right angles to length of rod. Drum revolves when line is drawn from reel during casting;

Fixed Spool reels.

Drum axis is parallel to length of rod. Drum does not revolve when line is drawn from reel during casting.

Method of casting.

- 1 Each caster shall have a marker or judge who shall position himself so as to have a clear view of the target(s) at all times. The marker or judge shall select a position which does not distract a participant whilst casting.
- 2 It is the duty of the marker or judge to accurately record all hits or strikes on the face of the target on the form provided.
- 3 It shall be the duty of the marker or judge to indicate each target in turn to the competitor.
- 4 A caster shall not prompt or intimidate the marker or judge regarding recorded score.
- 5 The marker or judge shall be selected by the Tournament Committee and directed to a vnt court.

Targets.

Targets for both 7.5 gram and 18 gram accuracy shall be a disk of 760 mm diameter. The target shall be placed on the ground with the remote edge raised 170 mm and front edge 50 mm above the ground level. Maximum thickness will be 10mm. Any suitable material shall be used in the construction of targets. Colour yellow only

The target for Arenburg shall be green coloured ground cloth or plastic, with 5 concentric rings marked white, maximum 20mm, having diameters from the centrepoint of 0.75 m, 1.35 m, 1.95 m, 2.55 m and 3.15 m. The centre target shall be a flat disc 0.75 metres diameter, maximum thickness 10mm and black in colour.

SPINNING ACCURACY ARENBERG. [Click Here for Court Diagram](#)

- Rod.** Single handed minimum length 1.37 metres, maximum length 2.50 metres, at least three (3) rod rings and tip ring 10 mm. Handle not to exceed 1/4 of rod length.
- Reel.** Open faced spinning reel, standard spool or same type.
- Line.**
- Lines.** Unrestricted, but the same diameter throughout the whole length. Minimum length of 20 metres for 7.5 gram accuracy events.
- Plug.** 7.5 gram weight. The 7.5-gram plastic plug will be drop-shaped with an even surface. The tolerance on weight for the 7.5-gram plug shall be a maximum 0.15 grams including eye. Any colour is allowable.
- Court.** Casting stations 1 and 5 to be in at a straight line from the centre of the disc over the groundsheet corner. The other three casting stations target to be placed between stations 1 and 5. The farthest, where possible, to be placed with the wind direction behind the caster. Each station to be marked with a starting board 1 meter long and a maximum 10 cms in height. All casting stations to be white in colour.
- Casting.**
- From each station 2 casts.
- | | | |
|-----------|--------------------------|---------------|
| Station 1 | Underhand pendulum cast. | Distance 10 M |
| Station 2 | Right handed side cast. | Distance 12 M |
| Station 3 | Over head cast. | Distance 18 M |
| Station 4 | Left handed side cast. | Distance 14 M |
| Station 5 | Optional style cast. | Distance 16 M |
- Distances to be measure from centre of the disc target to the midpoint of the casting station starting board.
- Underhand Pendulum Cast: This is properly executed when the plug is under the rod in the delivery stroke. Minimum length of overhang is 50 cm to eye of plug. Any posture is allowed.
- Right Hand Cast: This is properly executed when delivering the cast if the rod tip travels at least 1 metre from the right side of the casting direction and both the rod and casting hand are to the right of the casting direction ie the straight line between the centre-point of the caster and the target centre. The rod tip must travel in a horizontal plane when delivering the cast. i.e. parallel to ground. Any posture is allowed. Max length of overhang is 40 cm. Dragging the plug on the ground is prohibited and scores zero points.
- Overhead Cast: This is properly executed when the rod tip, before the delivery is above the head of the caster. Any posture and length of overhang is allowed.
- Left hand Cast: This is properly executed when delivering the cast if the rod tip travels at least 1 metre from the left side of the casting direction and both the rod and casting hand are to the left of the casting direction ie the straight line between the centrepoint of the caster and the target centre. The rod tip must travel in a horizontal plane when delivering the cast. i.e. parallel to ground. Any posture is allowed. Max length of overhang is 40 cm. Dragging the plug on the ground is prohibited and scores zero points.
- Time.** 5 minutes in all, moving between stations included.
- Score.** From centre 10 - 8 - 6 - 4 - 2 points. Maximum possible score 100 points.

7.5 GRAM SKISH PLUG. [Click Here for Court Diagram](#)

Rod. Single handed minimum length 1.37 metres, maximum length 2.50 metres, at least three (3) rod rings and tip ring 10 mm. Handle not to exceed 1/4 of rod length.

Reel. Open faced spinning reel, standard spool or same type.

Line. Unrestricted, but the same diameter throughout the whole length. Minimum length of 20 metres for 7.5 gram accuracy events.

Plug. 7.5 gram weight. The 7.5-gram plastic plug will be drop-shaped with an even surface. The tolerance on weight for the 7.5-gram plug shall be a maximum 0.15 grams including eye. Any colour is allowable.

Target. Target for 7.5 gram shall be a disk of 760 mm diameter. The target shall be placed on the ground with the remote edge raised 170 mm and front edge 50 mm above the ground level. Maximum thickness will be 10mm. Any suitable material shall be used in the construction of targets. Colour yellow only

Court. 1 casting target with five starting boards. The first starting board white, 1.00 metres long set at 10 metres with the following starting boards being set at 12 meters, 14 meters, 16 meters and 18 meters in a straight line from the target..

Casting. From each of the five (5) starting boards, starting at (10 metres), two (2) casts from each starting board. The caster goes through the court twice. In all Twenty (20) casts.

Time.
8 minutes.

Score.
All hits score five (5) points each. Maximum score possible 100 points.

7.5 GRAM SINGLE HANDED DISTANCE.

Rod.
Maximum length 2.80 meters.

Reel.
Same as for Arenberg.

Line25
Line, to be minimum diameter for full length of 0.18mm and a leader with a minimum diameter of 0.40 mm. Leader length is from the casting weight to the reel and the Caster must be in contact with leader whilst casting.

Plug.
7.5 gram plastic plug, to be knotted directly to the line, no loop or leader allowed.

Court.
At 1 00 metres distance, the court is 50 metres wide, measuring at a right angle to the perpendicular axis from the centre of the starting board, this board to be 1.50 metres long, white and 10 cm. high.

Casting.
Each caster to have 3 casts, one in each round in numerical order. Free style, but no centrifugal casts allowed.

Score.
Longest cast to win. 1 metre =1.5 points. Fractions count.

18 GRAM DOUBLE HANDED DISTANCE (FIXED SPOOL)

Rod.

Any rod.

Reel.

Any open faced spinning reel.

Line.

Line, to be minimum diameter for full length of 0.25mm and a leader with a minimum diameter of 0.40 mm.

Leader length is from the casting weight to the reel and the Caster must be in contact with leader whilst casting.

Plug.

18 gram plastic plug.

Court.

Same as for 7.5g single handed distance.

Casting.

Each caster to have three (3) casts, one (1) in each round in numerical order. Any casting style allowed.

Score.

Longest cast to win. 1 meter = 1.5 points. Fractions count.

18 GRAM SKISH PLUG. [Click Here for Court Diagram](#)

Rod

Any single handed rod.

Reel.

Multiplying reel with standard spool.

Line.

Unrestricted, but the same diameter throughout the whole length. Minimum length of 22 metres for 18 gram accuracy.

Plug.

The 18 gram plastic plug will be drop-shaped with an even surface. The tolerance on weight for the 18 gram plug shall be a maximum 0.30 grams including eye.

Any colour is allowable.

Target.

Target for 18 gram accuracy shall be a disk of 760 mm diameter. The target shall be placed on the ground with the remote edge raised 170 mm and front edge 50 mm above the ground level. Maximum thickness will be 10mm. Any suitable material shall be used in the construction of target. Colour yellow only

Court.

As per 7.5 Gram Accuracy event, however distances to be set as follows,

Starting board. 1: 12 metres from target

Starting board. 2: 14 metres from target

Starting board. 3: 16 metres from target

Starting board. 4: 18 metres from target

Starting board. 5: 20 metres from target

Casting.

From each of the five (5) Starting boards, starting at (12 metres), two (2) casts from each starting board.

The caster goes through the court twice. In all Twenty (20) casts..

Time.

10 minutes.

Score.

All hits score five (5) points each. Maximum score 100 points.

18 GRAM DOUBLE HANDED DISTANCE (REVOLVING DRUM).

Rod.

Any rod.

Reel.

Multiplying reel with standard spool.

Line.

Line, to be minimum diameter for full length of 0.25mm and a leader with a minimum diameter of 0.40 mm.

Leader length is from the casting weight to the reel and the Caster must be in contact with leader whilst casting.

Plug.

18 gram plastic plug.

Court.

Same as for 18 g fixed spool double handed distance.

Casting.

Same as for 18g fixed spool double handed distance.

Score

Same as for 18g fixed spool double handed distance.

General.

Caster has to leave the starting point within two (2) minutes from the finished cast.

TERMINOLOGY

AUSTRALIAN CASTING FEDERATION Inc.
A0041705E

TERMINOLOGY USED IN ACF BY-LAWS AND CASTING RULES

Break Record	Where a caster continues casting after having achieved a "Possible" score in the first round of an Event until a target is missed in an attempt for the caster to equal or set a new "Break Record" for an Event.
	By-Laws Administrative rules governing ACF Sanctioned Casting Tournaments, Sections and Events. Amended from time to time by the ACF Committee.
Casting Box	The designated area of 1.2 metres square in or on which a caster stands to cast any event. This casting area is to be indicated on all surfaces used, raised, matting or otherwise.
	Casting Platform A raised area on which a caster stands to cast for fly events. The Casting Box will be marked on all such platforms if the platform is greater than 1.2 metres square.
Casting Rules	The casting rules for all Casting Sections of the Australian Casting Federation and may only be changed by the vote of a majority of registered casters.
	Check Judge Checks a caster's attempt at a target when called upon by the Judge. The Check Judge also acts as Time Keeper and calls time when the time for a round or event expires.
	Check A call made to the Check Judge by the Judge because of uncertainty requesting him to call a score or not.
Class	Divisions of recognition for casting records.
Closed Event	A competition occurring concurrently with an Open Tournament. Can be a stand-alone club competition for members only.
	Constitution Interchangeable term for the ACF Rules of Association and Statement of Purposes.
	Court A configuration of targets in accuracy casting or the defining perimeter for distance casting.
	Delivery Cast Placement of the line on water or land following a back cast. See also Lay.
Event	A single casting Event such as the ICF Skish.

	Judge The person designated to give judgement on all casts and call the appropriate score for each attempt.
	Junior A registered caster under the age of eighteen years on the 1 st January of a calendar year. See also Senior.
	Lay Placement of the line on water or land following a back cast. See also delivery cast.
On Land	Description stating that a particular Event will be cast on land not water.
On Water	Description stating that a particular Event will be cast on water not land.
	Ordinary Equipment that is commercially available or the home made equivalent.
	Outside Interference Disruption to a competing caster from a source outside his control.
	Penciller See Scorer.
	Plastic Pool A pool constructed by means of plastic sheeting or likes to contain water for the purposes of conducting a casting tournament.
	Plug A specifically designed shaped weight used for competition casting.
	Possible The maximum score that a caster can achieve in a single Event.
	Roll Cast Casting a fly by means of rolling the line across the water with the rod in a vertical position. See also Switch Cast.
	Round A sequence of targets attempted in an Event. Or as in the case of the Brunn Shield one day's competition of the four rounds.
Sanction, Blanket	A Blanket Sanction by the ACF covers any number of nominated tournaments and championships arranged by any one Affiliated Club throughout any calendar year. The Committee of Management may create additional By-Laws in respect of Blanket Sanctions.
Sanction, ACF	An ACF Sanction is the permission granted by the ACF to Affiliated Clubs for the Affiliated Club's casting event to enable Registered Casters to compete in that event and claim Territory, State or Australian casting records. The Committee of Management may create additional By-Laws in respect of ACF Sanctions.
	Scorer (Penciller) A person designated to write down casters' scores as called by the Judge.
Section	One of the disciplines controlled by the ACF such as Fly Section, Weight Section, Plug Section.
Senior	A registered caster over the age of eighteen years on the 1 st January of a calendar year. See also Junior.

	Side Cast Where a line is cast with the rod in a horizontal position.
	Skish An acronym meaning 'Skill in Fishing' used to refer to a casting accuracy Event comprising several different rounds.
of Purposes	Statement Rules of the Australian Casting Federation. Sometimes referred to as the Constitution.
	Strip A length of line, usually known to a caster, measured from the rod hand to any part of the body.
	Switch Cast Casting a fly by means of rolling the line across the water with the rod in a horizontal position. See also Roll Cast.
	Target An official object at which a caster is required to hit with a fly, weight or plug.
	Tick Where a fly inadvertently touches the water in front of a caster either inside or outside the target.
Tie	Where two or more competitors finish a competition with equal points.

DRY FLY

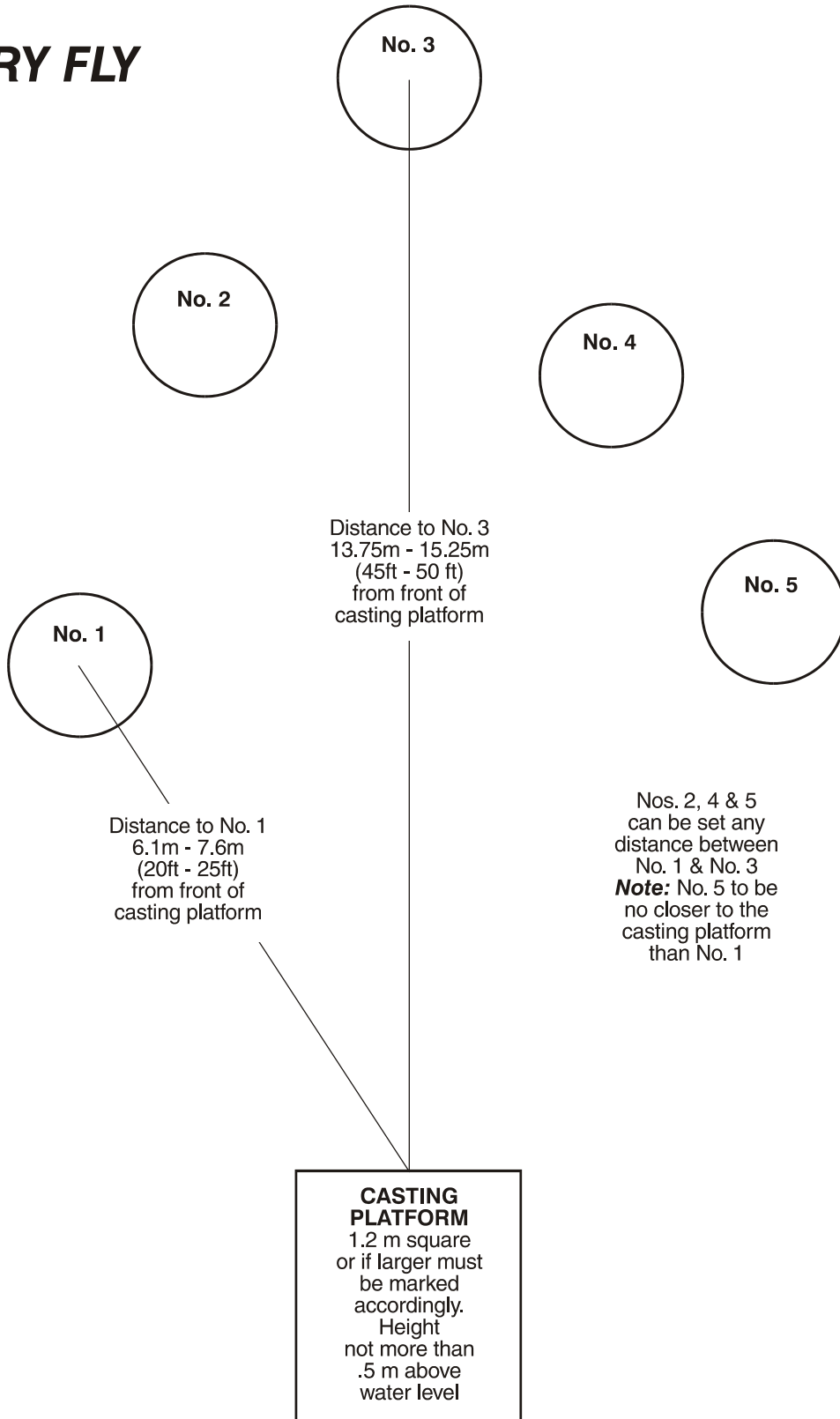

AUST. SKISH

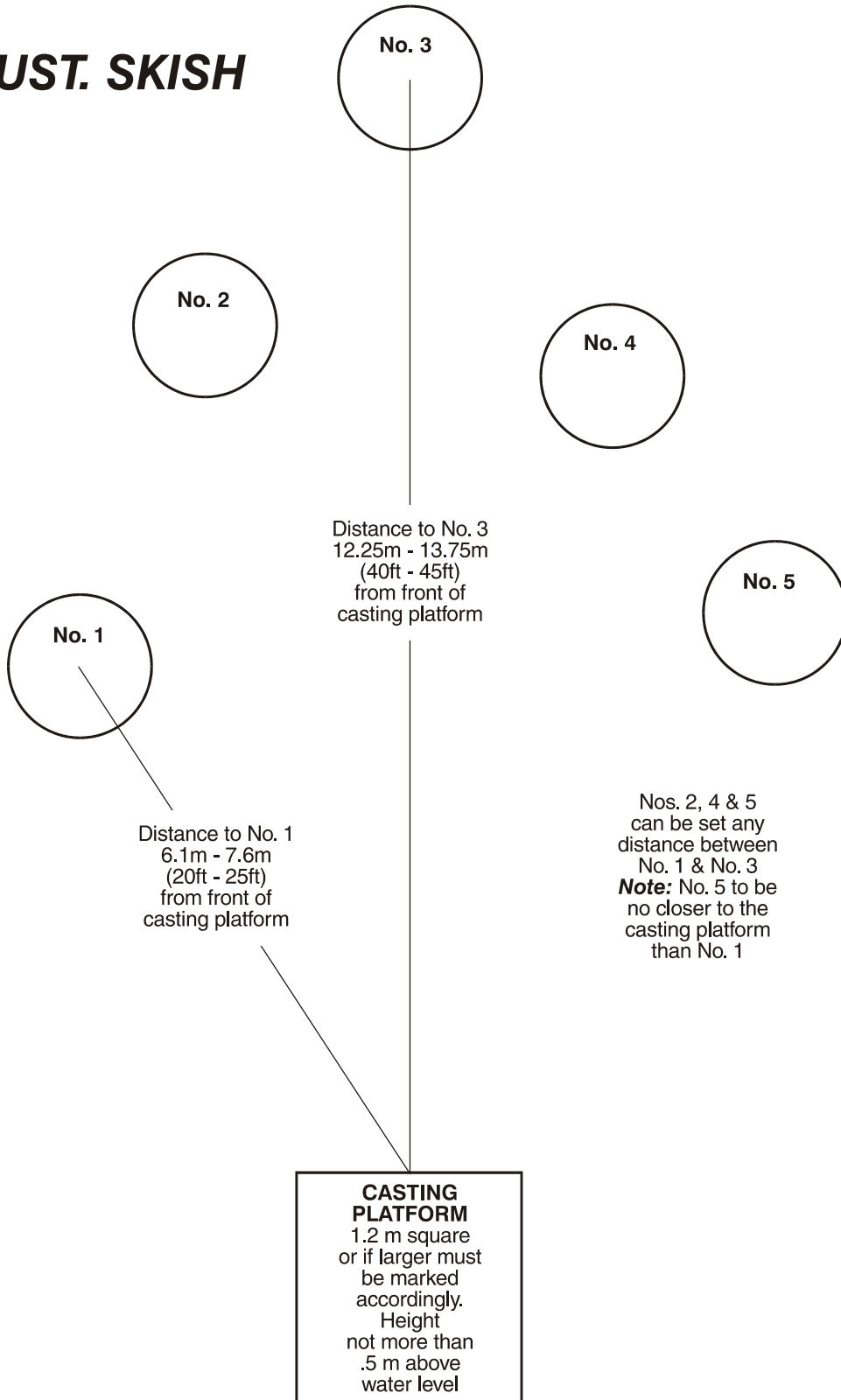

ICF SKISH

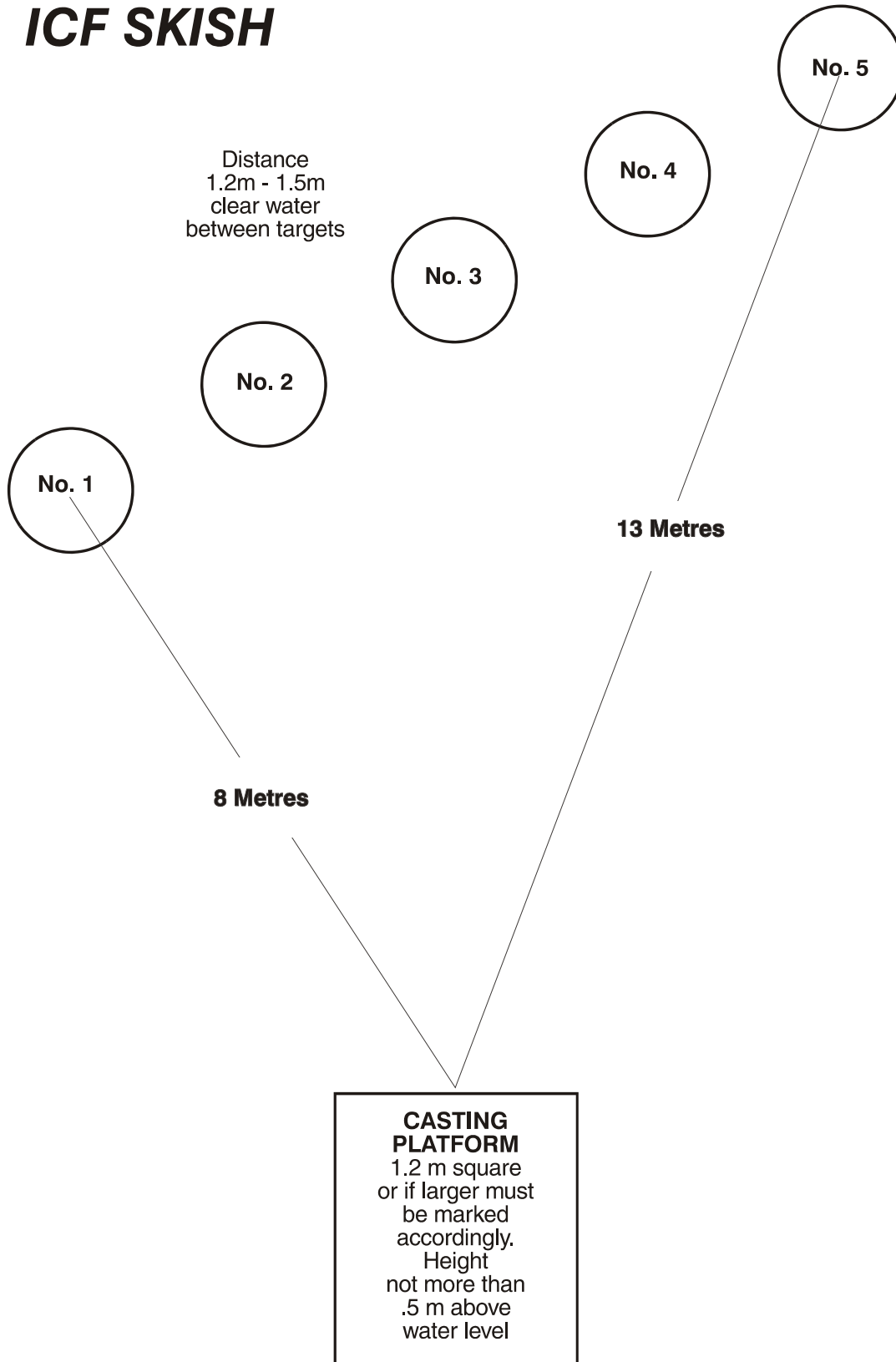

WET FLY

Targets shall be connected together in a straight line at 1.5m intervals

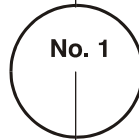
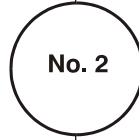
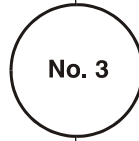
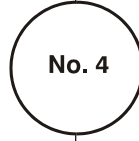
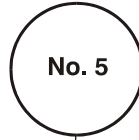

Distance to No. 1
10.75m from
centre of target
to front of
casting platform



ARENBURG

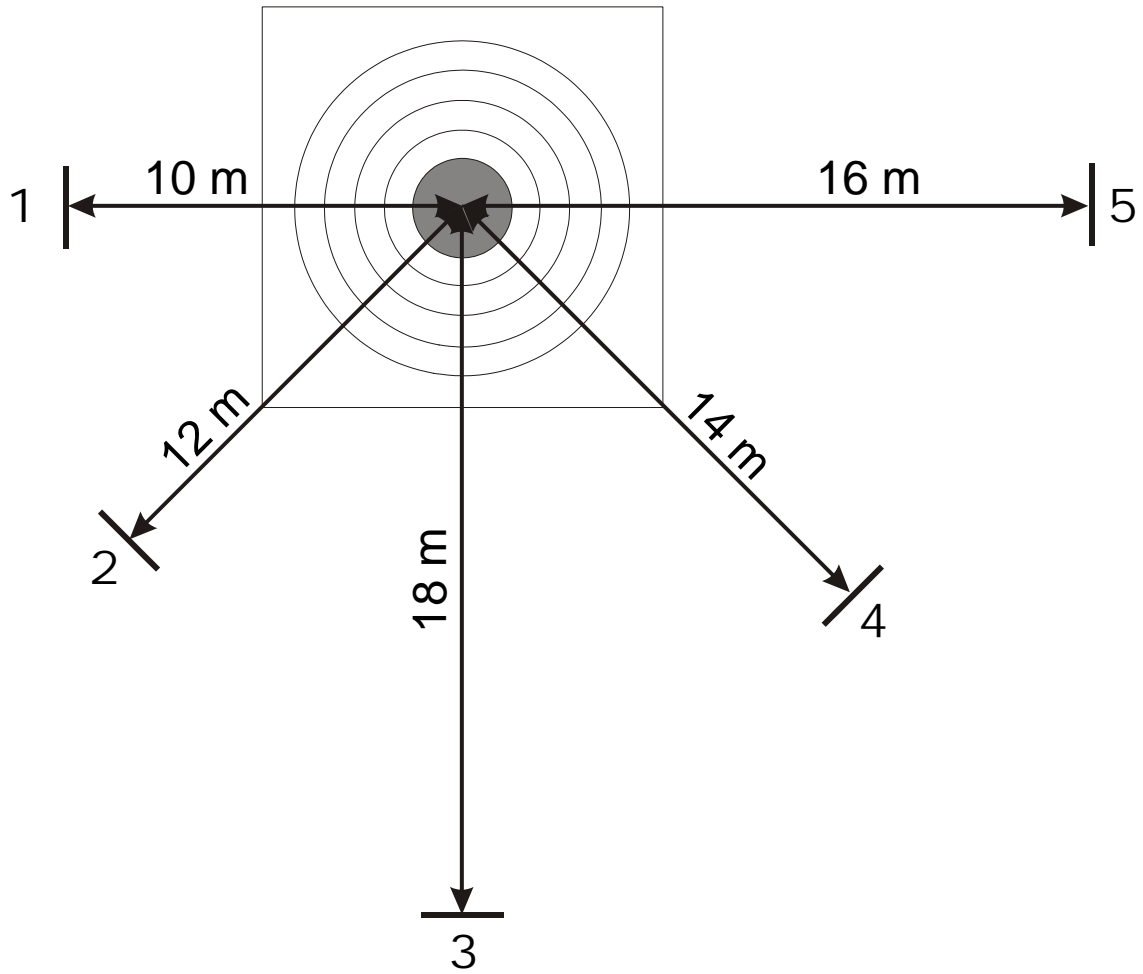

7.5 GRAM SKISH

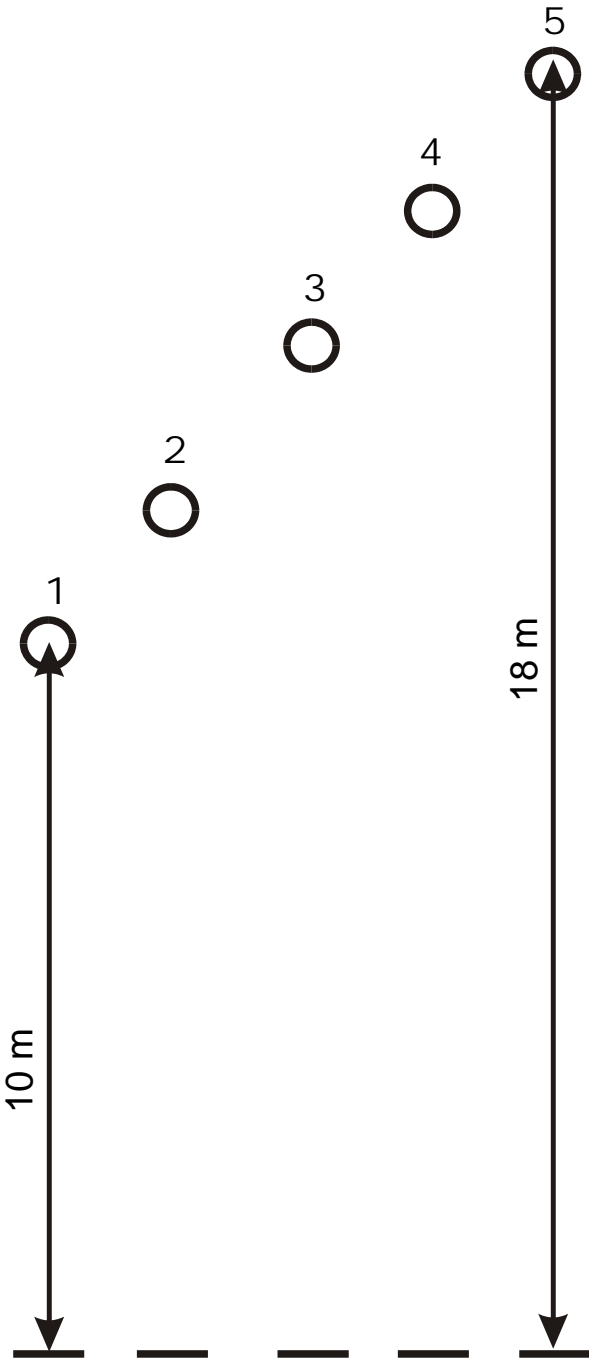

18 GRAM SKISH

